

LMR20

單軸
1-axis

軸棒線馬 Linear shaft motor

LMR20-05-RH-N



• CAD圖面可至www.toyorobot.com下載
Please download the CAD file from TOYO's website: www.toyorobot.com

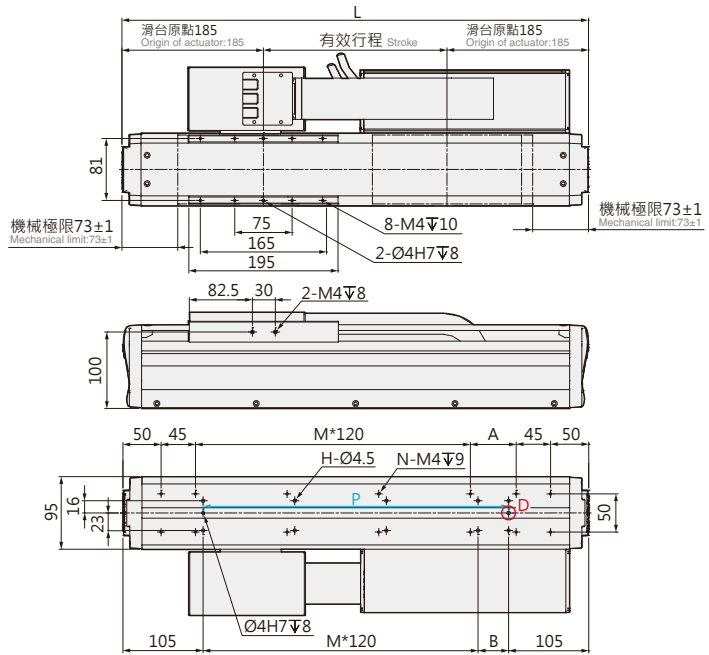
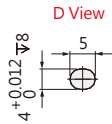
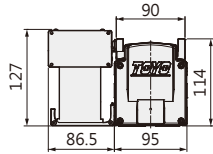
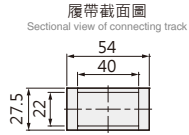

單位 Unit : mm

有效行程 stroke	180	240	300	360	420	480	540	600	660	720	780	840	900	960
L	550	610	670	730	790	850	910	970	1030	1090	1150	1210	1270	1330
A	120	60	120	60	120	60	120	60	120	60	120	60	120	60
B	100	40	100	40	100	40	100	40	100	40	100	40	100	40
P	340	400	460	520	580	640	700	760	820	880	940	1000	1060	1120
M	2	3	3	4	4	5	5	6	6	7	7	8	8	9
N	12	14	14	16	16	18	18	20	20	22	22	24	24	26
H	8	10	10	12	12	14	14	16	16	18	18	20	20	22
KG	10.2	10.9	11.6	12.3	12.9	13.6	14.3	15	15.7	16.3	17	17.7	18.4	19.1

LMR20-05-RH-D



• CAD圖面可至www.toyorobot.com下載
Please download the CAD file from TOYO's website: www.toyorobot.com

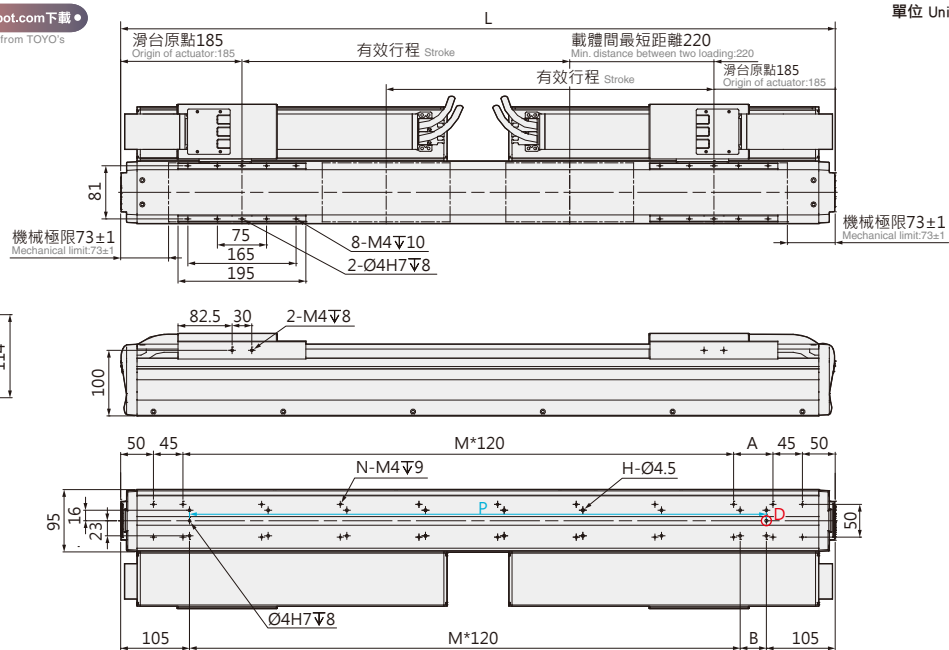
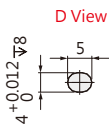
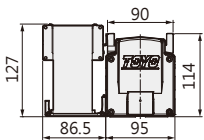
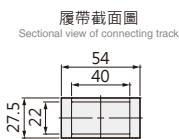

單位 Unit : mm

有效行程 stroke	80	140	200	260	320	380	440	500	560	620	680	740
L	670	730	790	850	910	970	1030	1090	1150	1210	1270	1330
A	120	60	120	60	120	60	120	60	120	60	120	60
B	100	40	100	40	100	40	100	40	100	40	100	40
P	460	520	580	640	700	760	820	880	940	1000	1060	1120
M	3	4	4	5	5	6	6	7	7	8	8	9
N	14	16	16	18	18	20	20	22	22	24	24	26
H	10	12	12	14	14	16	16	18	18	20	20	22
KG	16.3	17	17.7	18.4	18.5	19.7	20.4	21.1	21.8	22.4	23.1	23.8

免費服務專線：大陸 400-875-0009 台灣 0800-800-893
Toll-free Number China Taiwan

LMR20-05-LW-N



CAD圖面可至www.toyorobot.com下載
Please download the CAD file from TOYO's website: www.toyorobot.com

履帶截面圖
Sectional view of connecting track

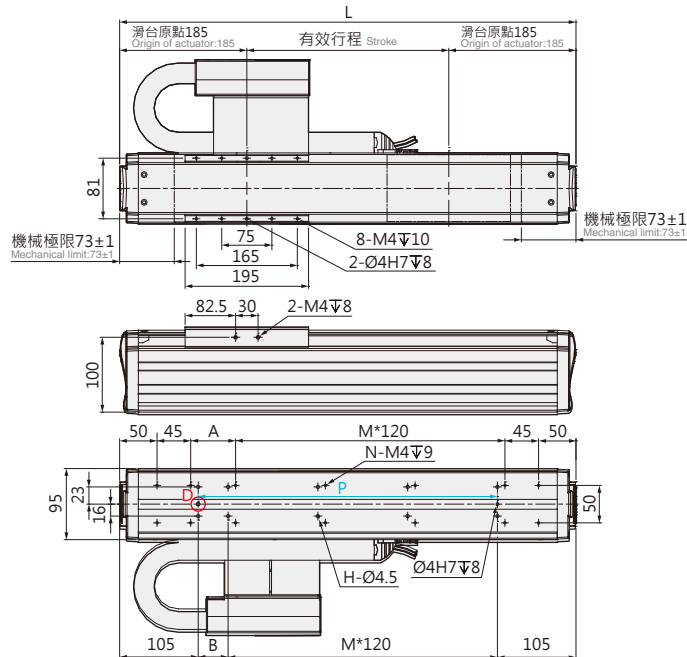
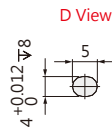
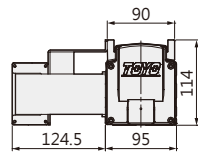
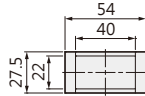

單位 Unit : mm

有效行程 stroke	180	240	300	360	420	480	540	600	660	720	780	840	900	960
L	550	610	670	730	790	850	910	970	1030	1090	1150	1210	1270	1330
A	120	60	120	60	120	60	120	60	120	60	120	60	120	60
B	100	40	100	40	100	40	100	40	100	40	100	40	100	40
P	340	400	460	520	580	640	700	760	820	880	940	1000	1060	1120
M	2	3	3	4	4	5	5	6	6	7	7	8	8	9
N	12	14	14	16	16	18	18	20	20	22	22	24	24	26
H	8	10	10	12	12	14	14	16	16	18	18	20	20	22
KG	10.3	11	11.6	12.2	12.8	13.5	14.1	14.7	15.1	16	16.6	17.2	17.9	18.5

LMR20-05-LW-D



CAD圖面可至www.toyorobot.com下載
Please download the CAD file from TOYO's website: www.toyorobot.com

履帶截面圖
Sectional view of connecting track

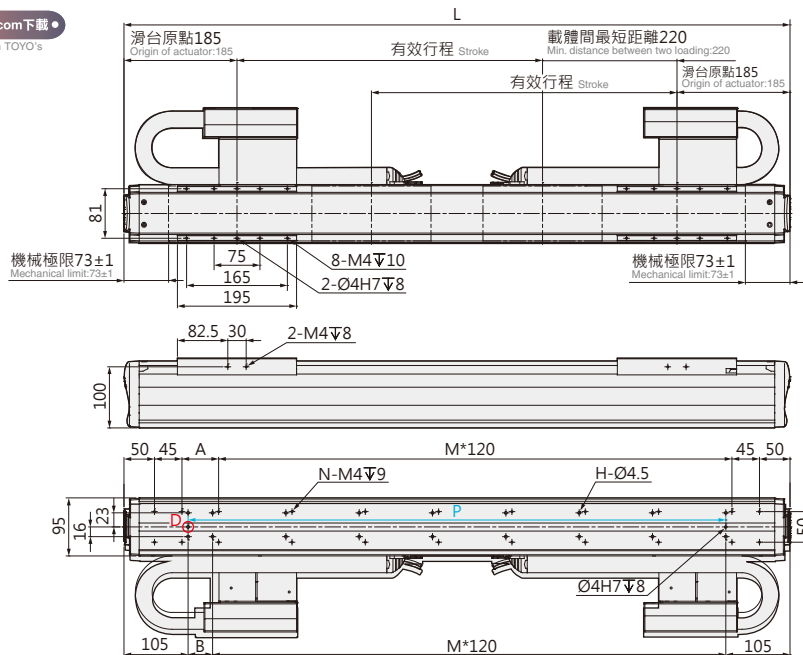
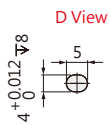
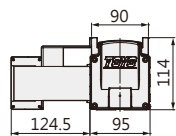
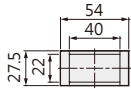

單位 Unit : mm

有效行程 stroke	80	140	200	260	320	380	440	500	560	620	680	740
L	670	730	790	850	910	970	1030	1090	1150	1210	1270	1330
A	120	60	120	60	120	60	120	60	120	60	120	60
B	100	40	100	40	100	40	100	40	100	40	100	40
P	460	520	580	640	700	760	820	880	940	1000	1060	1120
M	3	4	4	5	5	6	6	7	7	8	8	9
N	14	16	16	18	18	20	20	22	22	24	24	26
H	10	12	12	14	14	16	16	18	18	20	20	22
KG	16.4	17	17.6	18.2	18.8	19.4	20	20.6	21.2	21.8	22.4	23